

Edac Card-Edge Connectors

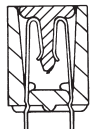

SINGLE-READOUT DUAL-READOUT POLARIZING INSERTS: BETWEEN CONTACT PART NO. 306-240-318 IN CONTACT PART NO. 307-240-328

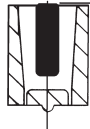
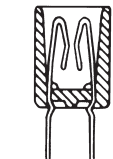
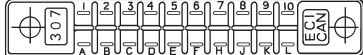
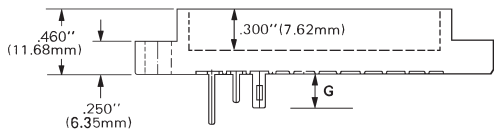
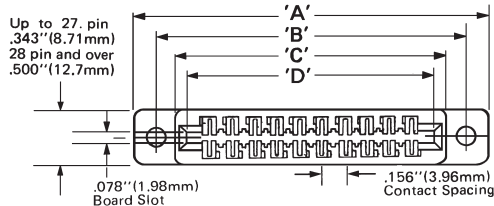
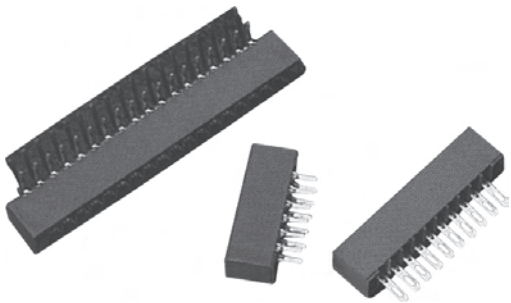
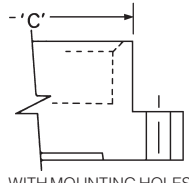
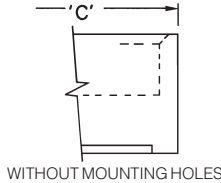
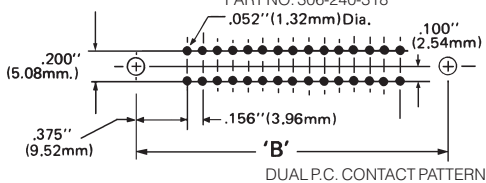

SERIES 307 CARD EDGE RECEPTACLE

Edac Series 307 Card-Edge Connectors accept printed circuit cards from .054" to .070" thick. Ribbon-type bifurcated contacts on .156" spacing provide target mating surfaces and exert firm, even pressure for smooth mating and greater reliability. Contacts, rated 5 amperes, are copper, nickel, tin alloy (CA725). Standard plating is gold on the mating area, tin-lead on the contact tails, nickel underplate. Maximum contact resistance 6 milliohms. Electro Sonic can supply a wide variety of terminations and mounting styles.

Insulator material is green Thermoplastic Polyester. Insulation resistance 5,000 Megohms minimum; dielectric withstanding voltage 2000V RMS at sea level. Withdrawal force 2 to 16 ounces per contact pair. MIL-C-21097 Qualified Products List (QPL) approved.

CARD GUIDE OPTIONS

Series 307 Receptacles are also available with Card Guides factory assembled to the connector. They have a No. 4-40 threaded insert for mounting. Alternatively, these Card Guides may be ordered separately and mounted to the connector in the field. It is necessary to order the 307 connector which has .156" diameter mounting holes (04 variation). Each Card Guide requires a Bushing, Part No. 345-250-442. Either a No. 4 Hex Head or Round Head Screw 5/16" long, with a nut and washer, will hold this assembly to a 1/16" panel.

No. of Contacts		Dimensions in Inches			
Single Readout	Dual Readout	A	B	C	D
6	12	1.842	1.532	1.246	1.100
7	14	1.998	1.688	1.402	1.256
10	20	2.466	2.156	1.870	1.724
11	22	2.622	2.312	2.026	1.880
12	24	2.778	2.468	2.182	2.036
13	26	2.934	2.624	2.338	2.192
14	28	3.090	2.780	2.494	2.348
15	30	3.246	2.936	2.650	2.504
18	36	3.714	3.404	3.118	2.972
22	44	4.338	4.028	3.742	3.596
24	48	4.650	4.340	4.054	3.908
25	50	4.806	4.496	4.210	4.064
28	56	5.274	4.964	4.678	4.532
30	60	5.586	5.276	4.990	4.884
36	72	6.522	6.212	5.926	5.780
43	86	7.614	7.304	7.018	6.872

TAIL LENGTHS

Contacts*	"G"
541	.495
521	.213
501	.237
500	.282
520	.213
540	.708

*Refer to third group of digits in part number.

POLARIZING KEYS

Cat. No.	Description	Net Price Per 1000
307-240-318	Between-Contact Type; no loss of contact position.	\$125.00
307-240-328	In-Contact Type; loses one contact position.	136.20

CARD GUIDE OPTIONS

Cat. No.	Description	Net Price Per 100
307-220-058	Offset .488" x 3.00 inches long	\$102.72
307-220-068	Offset .344" x 2.75 inches long	102.72
307-220-078	In-line 1.8 Inches long	102.72
345-250-442	Bushing	21.62

EDAC SERIES 307 CARD-EDGE RECEPTACLES—.156" SPACING

Cat. No.	Description	Contact Positions	Contacts	Net Price
WITH PLAIN .128" DIA. MOUNTING HOLES, CONVENTIONAL SOLDER EYELETS				
307-006-501-102	SINGLE READOUT	6	6	\$9.17
307-007-501-102		7	7	2.87
307-010-501-102		10	10	12.64
307-011-501-102		11	11	3.77
307-012-501-102		12	12	13.89
307-013-501-102		13	13	8.20
307-014-501-102		14	14	10.32
307-015-501-102		15	15	15.28
307-018-501-102		18	18	18.61
307-022-501-102		22	22	21.53
307-024-501-102		24	24	6.54
307-025-501-102		25	25	21.79
307-028-501-102		28	28	25.00
307-030-501-102		30	30	8.83
307-036-501-102		36	36	30.55
307-043-501-102	43	43	35.69	
307-012-500-202	DUAL READOUT	6	12	3.90
307-020-500-202		10	20	5.42
307-022-500-202		11	22	6.80
307-024-500-202		12	24	5.56
307-026-500-202		13	26	5.16
307-028-500-202		14	28	5.38
307-030-500-202		15	30	5.97
307-036-500-202		18	36	6.81
307-044-500-202		22	44	7.91
307-048-500-202		24	48	8.02
307-050-500-202		25	50	8.61
307-056-500-202		28	56	10.28
307-060-500-202		30	60	10.39
307-072-500-202		36	72	12.78
307-086-500-202		43	86	14.86

NOTE: Electro Sonic can supply many other variations not shown here.

Continued on next page...

Edac Card-Edge Connectors

EDAC SERIES 307 CARD-EDGE RECEPTACLES—.156" SPACING

Cat. No.	Description	Contact Positions	Contacts	Net Price
WITH PLAIN .128" DIA. MOUNTING HOLES, PC DIP SOLDER TAILS				
307-006-521-102	SINGLE READOUT	6	6	\$9.17
307-007-521-102		7	7	2.87
307-010-521-102		10	10	12.64
307-011-521-102		11	11	3.77
307-012-521-102		12	12	13.89
307-013-521-102		13	13	7.60
307-014-521-102		14	14	6.44
307-015-521-102		15	15	15.28
307-018-521-102		18	18	18.61
307-022-521-102		22	22	21.53
307-024-521-102	24	24	6.54	
307-025-521-102	25	25	21.79	
307-028-521-102	28	28	25.00	
307-030-521-102	30	30	8.83	
307-036-521-102	36	36	30.55	
307-043-521-102	43	43	35.69	
DUAL READOUT				
307-012-520-202	DUAL READOUT	6	12	3.90
307-020-520-202		7	14	5.42
307-022-520-202		11	22	5.11
307-024-520-202		12	24	5.56
307-026-520-202		13	26	5.16
307-028-520-202		14	28	5.38
307-030-520-202		15	30	5.97
307-036-520-202		18	36	6.81
307-044-520-202		22	44	7.91
307-048-520-202		24	48	8.02
307-050-520-202	25	50	8.61	
307-056-520-202	28	56	10.28	
307-060-520-202	30	60	10.39	
307-072-520-202	36	72	12.78	
307-086-520-202	43	86	14.86	

NOTE: Electro Sonic can supply many other variations not shown here.

EDAC SERIES 307 CARD-EDGE RECEPTACLES—.156" SPACING

Cat. No.	Description	Contact Positions	Contacts	Net Price
NO MOUNTING LUGS, PC DIP SOLDER TAILS				
307-006-521-101	SINGLE READOUT	6	6	\$9.17
307-010-521-101		10	10	12.64
307-012-521-101		12	12	13.89
307-015-521-101		15	15	15.28
307-018-521-101		18	18	18.61
307-022-521-101		22	22	21.53
307-025-521-101		25	25	21.79
307-028-521-101		28	28	25.00
307-030-521-101		30	30	8.83
307-036-521-101		36	36	30.55
307-043-521-101	43	43	35.69	
DUAL READOUT				
307-012-520-201	DUAL READOUT	6	12	3.90
307-020-520-201		10	20	5.42
307-024-520-201		12	24	5.56
307-030-520-201		15	30	5.97
307-036-520-201		18	36	6.81
307-044-520-201		22	44	7.91
307-050-520-201		25	50	8.61
307-056-520-201		28	56	10.28
307-060-520-201		30	60	10.39
307-072-520-201		36	72	12.78
307-086-520-201	43	86	14.86	

NOTE: Electro Sonic can supply many other variations not shown here.

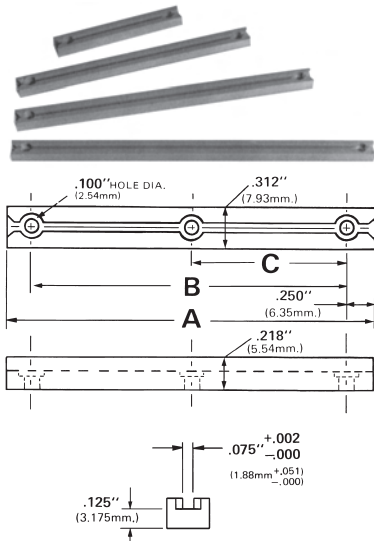

EDAC SERIES 616 UNI-GUIDES

Edac Series 616 UNI-GUIDES are universal guides which allow the engineer full

flexibility in the design of card cages and equipment. Made of high temperature resistant grey polycarbonate with wide bevelled edges for easy card alignment. Fits standard 1/16" thick PC boards. Easy to install with two or three pop rivets, 3/32" dia. Can also be mounted in "back to back" configuration using eyelets.

Cat. No.	Dimensions in Inches			Net Price Per 100		
	A	B	C	1-499	500-999	1000-Up
616-220-301	6.375	5.875	—	\$68.40	\$59.50	\$52.40
616-220-302	2.500	2.000	—	37.50	32.61	28.73
616-220-303	4.500	4.000	—	50.19	43.65	38.48
616-220-304	5.500	5.000	—	56.76	49.35	43.50
616-220-305	8.000	7.500	3.750	81.10	70.50	62.10
616-220-306	9.000	8.500	4.250	91.20	79.30	69.60
616-220-307	11.000	10.500	5.250	110.60	96.17	84.75

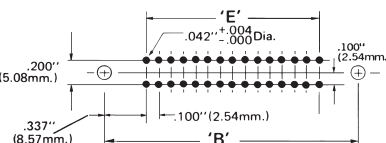
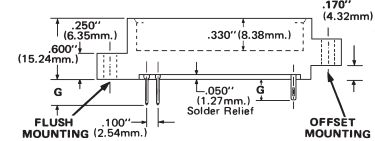
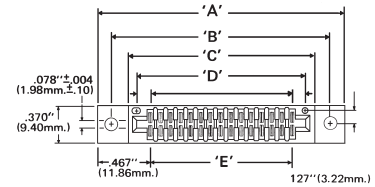
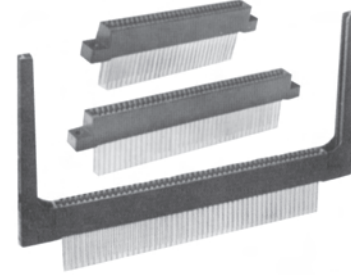

DUAL PC CONTACT PATTERN

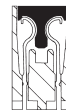

IN CONTACT
PART NO. 345-240-328



BETWEEN CONTACTS
PART NO. 345-240-318

SERIES 345 CARD EDGE RECEPTACLE

Edac Series 345 Card-Edge Connectors accept printed circuit cards from .054" to .070" thick. They feature pre-loaded, single beam, cantilever bifurcated contacts. Contact rating 3 amperes; maximum contact resistance 6 milliohms. Contact plating: gold on the mating area, tin-lead on the contact tails, nickel under-plate.

Insulator material is green Thermoplastic Polyester. Insulation resistance 5000. Megohms minimum; dielectric withstanding voltage 2000V RMS at sea level. Withdrawal force 2 to 10 ounces per contact pair.

Continued on next page...

Edac Card-Edge Connectors

SERIES 345 CARD EDGE RECEPTACLE

EDAC Series 345 Card-Edge Connectors accept printed circuit cards from .054" to .070" thick. They feature pre-loaded, single beam, cantilever bifurcated contacts. Contact rating 3 amperes; maximum contact resistance 6 milliohms. Contact plating: gold on the mating area, tin-lead on the contact tails, nickel underplate.

Insulator material is green Thermoplastic Polyester. Insulation resistance 5000.

No. of Contacts		A	B	C	D	E
Single Readout	Dual Readout					
6	12	1.435	1.175	0.860	0.700	0.500
8	16	1.635	1.375	1.060	0.900	0.700
10	20	1.835	1.575	1.260	1.100	0.900
12	24	2.035	1.775	1.460	1.300	1.100
13	26	2.135	1.875	1.560	1.400	1.200
15	30	2.335	2.075	1.760	1.600	1.400
17	34	2.535	2.275	1.960	1.800	1.600
18	36	2.635	2.375	2.060	1.900	1.700
20	40	2.835	2.575	2.260	2.100	1.900
22	44	3.035	2.775	2.460	2.300	2.100
24	48	3.235	2.975	2.660	2.500	2.300
25	50	3.335	3.075	2.760	2.600	2.400
30	60	3.835	3.575	3.260	3.100	2.900
31	62	3.935	3.675	3.360	3.200	3.000
32	64	4.035	3.775	3.460	3.300	3.100
35	70	4.335	4.075	3.760	3.600	3.400
36	72	4.435	4.175	3.860	3.700	3.500
40	80	4.835	4.575	4.260	4.100	3.900
43	86	5.135	4.875	4.560	4.400	4.200
50	100	5.835	5.575	5.260	5.100	4.900
65	130	7.335	7.075	6.760	6.600	6.400

TAIL LENGTHS

Contact*	"G"
500	.260
520	.175
541	.750

*Refer to third group of digits in part number.

Cat. No.	Description	Net Price Per 100
----------	-------------	-------------------

THE AVAILABLE CARD GUIDES ARE:

345-220-058	Offset .488" x 3.00 inches long	\$85.61
345-220-078	In-line 3.00 inches long	85.61
345-250-442	Bushing	21.62

FOR OFFSET MOUNTING RECEPTACLES USE:

346-220-058	Offset .467" x 3.00 inches long	114.00
346-220-078	In-line 1.8" long	85.61
345-250-442	Bushing	21.62

EDAC SERIES 345 CARD-EDGE RECEPTACLES, FLUSH MOUNTING, .100" SPACING

Cat. No.	Description	Contact Positions	Contacts	Net Price
----------	-------------	-------------------	----------	-----------

WITH PLAIN .128" DIA. MOUNTING HOLES, CONVENTIONAL SOLDER EYELETS

345-012-500-102	SINGLE READOUT	12	12	\$3.25
345-015-500-102		15	15	5.85
345-017-500-102		17	17	6.15
345-024-500-102		24	24	6.75
345-025-500-102		25	25	4.53
345-030-500-102		30	30	8.09
345-036-500-102		36	36	8.92
345-040-500-102		40	40	6.33
345-050-500-102		50	50	7.49
345-012-500-202	DUAL READOUT	6	12	8.88
345-020-500-202		10	20	9.99
345-024-500-202		12	24	10.75
345-026-500-202		13	26	10.88
345-030-500-202		15	30	11.25
345-034-500-202		17	34	6.38
345-036-500-202		18	36	12.00
345-044-500-202		22	44	13.75
345-050-500-202		25	50	14.00
345-060-500-202		30	60	14.38
345-062-500-202		31	62	14.63
345-072-500-202		36	72	15.87
345-080-500-202		40	80	8.38
345-086-500-202		43	86	17.63
345-100-500-202		50	100	19.38

NOTE: Electro Sonic can supply many other sizes and variations not shown here.

EDAC SERIES 345 CARD-EDGE RECEPTACLES, FLUSH MOUNTING, .100" SPACING

Cat. No.	Description	Contact Positions	Contacts	Net Price
----------	-------------	-------------------	----------	-----------

WITH PLAIN .128" DIA. MOUNTING HOLES, PC DIP SOLDER TAILS

345-012-520-102	SINGLE READOUT	12	12	\$3.25
345-015-520-102		15	15	3.55
345-017-520-102		17	17	3.75
345-024-520-102		24	24	4.42
345-025-520-102		25	25	4.53
345-030-520-102		30	30	5.04
345-036-520-102		36	36	5.87
345-040-520-102		40	40	6.33
345-050-520-102		50	50	7.49
345-012-520-202	DUAL READOUT	6	12	4.63
345-020-520-202		10	20	4.75
345-024-520-202		12	24	5.00
345-026-520-202		13	26	5.24
345-030-520-202		15	30	5.50
345-034-520-202		17	34	4.87
345-036-520-202		18	36	5.75
345-044-520-202		22	44	6.38
345-050-520-202		25	50	6.75
345-060-520-202		30	60	7.38
345-062-520-202		31	62	7.75
345-072-520-202		36	72	8.38
345-080-520-202		40	80	8.38
345-086-520-202		43	86	9.38
345-100-520-202		50	100	10.38

NOTE: Electro Sonic can supply many other sizes and variations not shown here.

POLARIZING KEYS FOR SERIES 345

Cat. No.	Description	Net Price Per 1000
----------	-------------	--------------------

345-240-318	Between-Contact Type; no loss of contact position.	\$94.59
345-240-328	In-Contact Type; loses one contact position.	129.48

SERIES 346 CARD EDGE RECEPTACLE

EDAC SERIES 346 CARD-EDGE RECEPTACLES, .170" OFFSET MOUNTING, .125" SPACING

Cat. No.	Description	Contact Positions	Contacts	Net Price
----------	-------------	-------------------	----------	-----------

WITH PLAIN .128" DIA. MOUNTING HOLES, CONVENTIONAL SOLDER EYELETS

346-015-500-602	SINGLE READOUT	15	15	\$3.46
346-018-500-602		18	18	3.81
346-022-500-602		22	22	3.97
346-024-500-602		24	24	4.99
346-040-500-602		40	40	6.09
346-020-500-802	DUAL READOUT	10	20	6.88
346-030-500-802		15	30	7.75
346-036-500-802		18	36	8.38
346-044-500-802		22	44	9.02
346-050-500-802		25	50	9.81
346-056-500-802		28	56	10.13
346-060-500-802		30	60	10.63
346-062-500-802		31	62	10.63
346-070-500-802		35	70	11.50
346-072-500-802		36	72	11.63
346-080-500-802		40	80	12.37
346-086-500-802		43	86	13.00
346-100-500-802		50	100	14.13

NOTE: Electro Sonic can supply many other variations not shown here.

EDAC SERIES 346 CARD-EDGE RECEPTACLES, .170" OFFSET MOUNTING, .125" SPACING

Cat. No.	Description	Contact Positions	Contacts	Net Price
----------	-------------	-------------------	----------	-----------

WITH PLAIN .128" DIA. MOUNTING HOLES, PC DIP SOLDER TAILS

346-018-520-602	SINGLE READOUT	18	18	\$5.16
346-022-520-602		22	22	5.67
346-024-520-602		24	24	6.13
346-040-520-602		40	40	8.01
346-020-520-802	DUAL READOUT	10	20	4.50
346-030-520-802		15	30	5.00
346-036-520-802		18	36	5.38
346-044-520-802		22	44	6.31
346-050-520-802		25	50	6.38
346-056-520-802		28	56	6.63
346-060-520-802		30	60	6.79
346-062-520-802		31	62	6.88
346-070-520-802		35	70	7.13
346-072-520-802		36	72	7.38
346-080-520-802		40	80	8.38
346-086-520-802		43	86	9.50
346-100-520-802		50	100	14.13

NOTE: Electro Sonic can supply many other variations not shown here.