

PC TEST POINT TERMINALS - SLOTTED AND LOOP TYPES

FEATURES: Low profile, space saving designs for dense packaging. Safe practical, economical replacement for wire-wrap posts. Easy mount design, ideal for wave soldering. Re-fit PC boards without need for re-design. Positive grip when using J hooks, EZ hooks, grabbers, clips, tips and probes.

Cat. No.	Material	Dimensions (Inches)				Net Price
		A	B	C	D	
4950	.025" Brass, Tin Plate	.098	.197	.126	.039	\$.12
1031	.020" Brass, Tin Plate	.075	.270	.156	.035	.13
1035	.020" Brass, Tin Plate	.100	.335	.117	.039	.12
1039	.025" Brass, Tin Plate	.138	.394	.160	.055	.13
1040	.025" Brass, Tin Plate	.110	.390	.115	.039	.11
1033	.025" Brass, Tin Plate	.118	.296	.125	.054	.12
1038	.020" Brass, Tin Plate	.110	.395	.156	.069	.13
1249	.020" Brass, Tin Plate	.118	.445	.195	.047	.13
680	.015" Brass, Tin Plate	.312	.718	.172	.062	.11
1041	.032" Brass, Tin Plate	.110	.630	.275	.050	.16

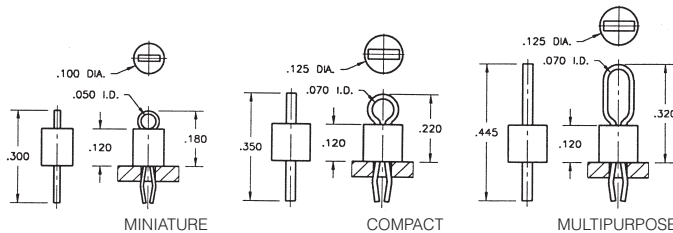

PC TEST POINTS SNAP-IN MOUNTING COLOUR CODED

MATERIAL: Terminals: Phosphor bronze wire, tin plated. Base: Valox, UL 94V-0

Cat. No.	Terminals	Mounting Details	Base Colour	Net Price
MINIATURE				
5000	.010 x .020	Hole: 0.40 dia., Centres: .100 x .100	Red	\$.24
5001			Black	.24
5002			White	.24
5003			Orange	.24
5004			Yellow	.24
COMPACT				
5005	.015 x .032	Hole: 0.63 dia., Centres: .125 x .125	Red	.24
5006			Black	.24
5007			White	.24
5008			Orange	.24
5009			Yellow	.24
MULTIPURPOSE				
5010	.015 x .032	Hole: 0.63 dia., Centres: .125 x .125	Red	.24
5011			Black	.24
5012			White	.24
5013			Orange	.24
5014			Red	.24

MICRO PINS

FEATURES: Precision engineered and manufactured. Space saving design for high density packaging. Ideal for mating with our standard line of micro jacks. Available in press-fit and swage. **MATERIAL:** Brass, ASTM-B16. Plating: Gold: .000010 per MIL-G-45204, Type II. Tin: .000200 to .000300 per MIL-T-10727, Type 1.

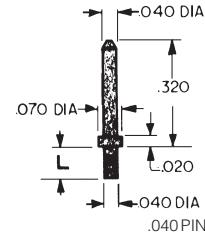

Cat. No.	"L" Lgth.	Bd Thk.	Net Price Per 1000	
GOLD PLATED				
1405-1	.051	.032	\$123.62	
1405-2	.082	.062	123.62	
1405-3	.113	.093	123.62	
TIN PLATED				
1425-1	.051	.032	77.05	
1425-2	.082	.062	77.05	
1425-3	.113	.093	77.05	

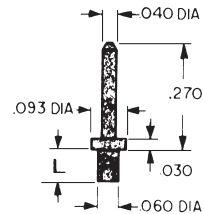

Cat. No.	"L" Lgth.	Bd Thk.	Net Price Per 1000	
			1-499	500-Up
GOLD PLATED				
1402-3	.125	.093	\$153.34	\$107.95

MICRO JACKS

Closed entry. Beryllium copper spring maintains retention after numerous insertions. Ideal for mounting transistors, resistors, diodes, I.C's and other miniature components. Designed for tight space-saving applications for both conventional and printed circuit boards. Easy removal and replacement for module repair purposes. Specifications: Body: Brass (QQ-B-626). Spring: Beryllium Copper (QQ-C-533). Plating: Gold .000020 (MIL-G-45204 Type II). Tin: .000200 to .000300 (MIL-T-10727, Type 1) over nickel .000100 to .000150 (QQ-N-290).

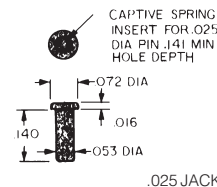

Cat. No.	Description	Net Price Per 1000
1413	Gold Plated	\$238.21
1433	Tin Plated	133.39

Retains .016 to
.022 Dia. Leads.
Press Fits into
.055 Dia. Hole

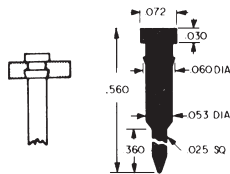

I.C. SOCKET CONTACTS

Cat. No.	Description	Net Price Per 1000
3501	Gold Plated	\$264.63
3505	Tin Plated	151.79

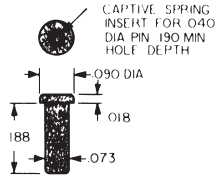

.040 JACK

Cat. No.	Description	Net Price Per 1000
1417	Gold Plated	\$401.54
1437	Tin Plated	257.41

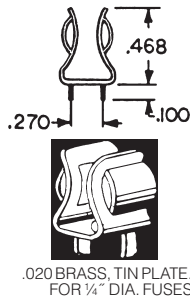
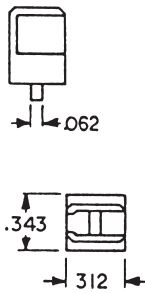

.020 BRASS, TIN PLATE.
FOR 1/4" DIA. FUSES

3AG PC CLIP FOR 2AG, 3AG AND 5MM FUSES

Snap-fit and press-fit designs for wave soldering. Low profile, space saving. Available with orientation tabs and end stops. Low contact resistance. Rated 15 amps. Economical and easy to assemble.

Cat. No.	Net Price Per 1000
3530	\$167.03

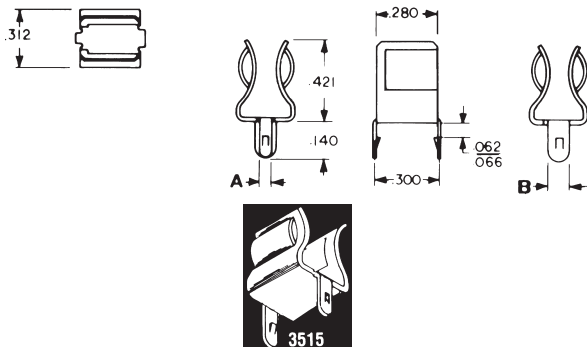

.020 BRASS, TIN PLATE.
FOR 1/4" DIA. FUSES.

3AG SNAP-IN POLARITY CLIP

Cat. No.	A	B	Net Price Per 1000		
			1-499	500-999	1000-Up
3515	.060	.060	\$245.27	\$172.67	\$111.50

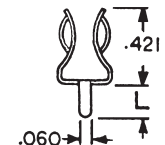
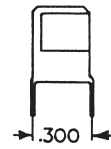

.020 BRASS, TIN PLATE.
FOR 1/4" DIA. FUSES

3AG PC CLIPS

Cat. No.	L	Net Price Per 1000		
		1-499	500-999	1000-Up
3529	.140	\$122.44	\$86.20	\$55.66

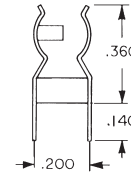
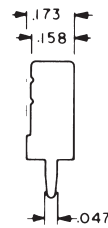

.016 BRASS, TIN PLATED

5MM PC CLIP

Cat. No.	Net Price Per 1000
3519	\$217.88

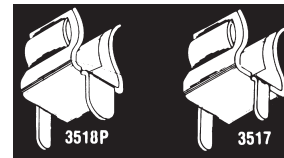
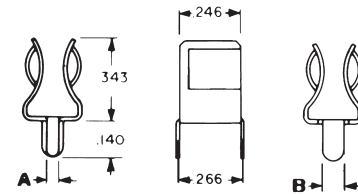

.020 BRASS, TIN PLATED.

5MM PC POLARITY CLIP

Cat. No.	A	B	Net Price Per 1000		
			1-499	500-999	1000-Up
3517	.060	.060	\$137.11	\$96.53	\$62.33
3518P	.060	.093	137.11	96.53	62.33