

E



F



K

"TINI-PLUG" MINIATURE PHONE PLUGS

Miniature 2-conductor phone plugs for use with "TINI-JAX" only 1/3 the size of standard phone plugs. Handle 1 1/4" overall length, are plastic or brass, nickel plated.

Cat. No.	Fig.	Handle	Ter-minals	Net Price Each			
				1-9	10-99	100-499	500-Up
740	E	Black	Screw	\$9.54	\$4.76	\$3.34	\$2.47
745	E	Red	Screw	9.54	4.76	3.34	2.47
750	E	Black	Solder	9.31	4.66	3.25	2.41
755	E	Red	Solder	9.31	4.66	3.25	2.41
770	E	Shielded	Screw	13.47	6.74	4.71	3.48
780	E	Shielded	Solder	12.57	6.29	4.41	3.26

"MICRO-PLUG" SUB-MINIATURE PHONE PLUGS

Sub-miniature 2-conductor phone plugs, only 1 1/64" long; 1/4" O.D., .097" dia. sleeve. Mate with No. TR2A. Have screw-on handles in black, red or natural anodized aluminum; accommodates cables up to 7/64" dia. All plugs have integral cable clamps.

Cat. No.	Fig.	Handle	Net Price Each			
			1-9	10-99	100-499	500-Up
850	F	Black anodize	\$9.43	\$4.71	\$3.30	\$2.43
855	F	Red anodize	9.43	4.71	3.30	2.43
880	F	Natural anodize	9.43	4.71	3.30	2.43

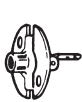

K



L

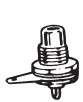

M



P



R

PHONO JACKS AND PLUGS

Low cost 2-cond. jacks and plugs for record players, FM-AM tuners, tape recorders, test equipment, etc. **3501MC** has 3/8" O.D. shell and cable clamp. **3501FP** for front panel mount in 1/4" hole, in panels up to 1/8" thick. **3501FR** for rear panel mount in 3/8" hole, in panels up to 1 3/64" thick. **3502** has unique cable clamp with 1 3/32" O.D. shielded removable handle. **3503** ext. jack has shielded removable handle, 1 3/32" O.D. with cable clamp. **3558 Series**, new color coded phono plugs with cable clamp and "snap-on" plastic handles in Red, Black, and White.

Cat. No.	Fig.	Description	Net Price Each		
			1-9	10-99	100-Up
3501F	K	Chassis jack	\$4.60	\$3.44	\$2.31
3501M	—	Plug, less cable clamp	2.56	1.16	.78
3501MC	L	Plug with cable clamp	5.24	2.36	1.56
3501FR	—	Chassis jack	4.26	3.22	2.12
3501FP	M	Chassis jack	5.39	2.69	1.88
3502	N	Plug	5.84	2.92	2.05
3503	P	Extension jack	8.42	4.22	2.94
3558-1	R	Plug, red handle	4.49	3.37	2.25
3558-2	R	Plug, black handle	4.49	3.37	2.25
3558-5	R	Plug, white handle	4.49	3.37	2.25



LL



MM



N

"RF-JAX" PHONO JACKS AND "RF-PLUG" PHONO PLUGS

Standard phono jacks and plugs with nylon insulation. For use in radio frequency applications—low cost, max. insulation resistance. No. **3504M**, 3/8" O.D. No. **3505F** mounts front of panel in 3/8" hole—fits panel up to 1 1/64" thick. No. **3507** has 1 3/32" O.D. shielded, screw-on handle with cable clamp.

Cat. No.	Fig.	Description	Net Price Each			
			1-9	10-99	100-499	500-Up
3504M	LL	Plug	\$4.86	\$2.21	\$1.47	\$1.00
3505F	MM	Chassis jack	6.74	3.37	2.36	1.74
3507	N	Plug	8.42	4.22	2.94	2.17



3502RA



3502A

HEAVY-DUTY PHONE PLUGS

The 3502A series feature a solder cup on a solid center conductor for fast, easy termination. Its large cable clamp provides better strain relief for larger cables and a longer cable clamp for easier plug assembly. Longer Knurled handles allow for easier gripping. These plugs can be used in audio, consumer electronic equipment, broadcast studios, home recording equipment, audio cable assembly manufacturers, instrumentation, and test equipment. Current carry @ working voltage: 6 amps. Dielectric withstand voltage: 500VAC. Contact resistance: <0.020 ohms. Insulation resistance @ 500VDC: 2,000 megohms (min.).

Cat. No.	Description	Net Price Each		
		1-9	10-99	100-Up
STRAIGHT PLUGS				
3502A	Nickel-plated plug finger and handle	\$5.84	\$2.92	\$2.05
3502AAU	Gold-plated plug finger and nickel plated handle	7.41	3.72	2.60
3502ABAU	Gold-plated plug finger and black epoxy finished handle	8.42	4.22	2.94
RIGHT ANGLE PLUGS				
3502RA	Nickel-plated plug finger and handle	13.47	6.74	4.71
3502RAAU	Gold-plated plug finger and nickel plated handle	14.59	7.31	5.11
3502RABAU	Gold-plated plug finger and black epoxy finished handle	15.83	7.91	5.54

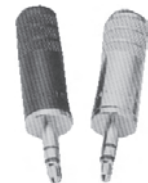

SWITCHCRAFT 3.5MM HEAVY-DUTY STEREO PLUG

FEATURES AND BENEFITS: One piece tip rod with flat for easy solderability. Compliments current line of 3.5mm jacks, 35RAP Series. Insert molded plug finger. Heavy duty cable clamp provides better strain relief for larger cables. Longer cable clamp for easier plug assemble and more room for solder connections. Knurl on the back of handle provides ergonomic gripping surface to tighten plug. Tubular insulator included to prevent solder joints from contacting handle. Longer handle for improved gripping surface and easy plug withdrawal from jack. Large solder terminals for easy solderability. **SPECIFICATIONS:** Contact resistance: <0.020 ohms. Dielectric withstand voltage: 250VAC (min.). Insulation resistance @ 500VDC: 2,000 megohms (min.). Working voltage: 250VAC, 140VDC. Current carry @ working voltage: 4 amps. Temperature range: 0°C to 66°C. Life: 5000 cycles. Maximum cable size: 250" dia. Solder terminals. Copper alloy, tin-plate. Tubular insulation: Clear plastic. Overall length: 1.700" (43.18mm). Width: Ø.406" (Ø10.31).

Cat. No.	Description	Net Price
STRAIGHT PLUGS		
35HDBN	Black handle, nickel plug	\$13.92
35HDBAU	Black handle, gold plug	15.71
35HDNN	Nickel handle, nickel plug	13.92
35HDNAU	Nickel handle, gold plug	15.71
RIGHT ANGLE PLUGS		
35HDRANN	Nickel handle, nickel plug	22.78
35HDRABAU	Black handle, gold plug	31.65
35HDRANAU	Nickel handle, gold plug	31.65

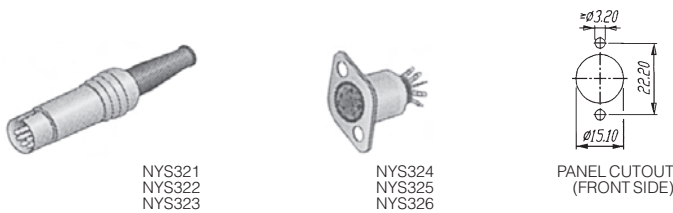

NYS321
NYS322
NYS323

NYS324
NYS325
NYS326

PANEL CUTOUT
(FRONT SIDE)

NEUTRIK REAN DIN CONNECTORS

Contact resistance: ≤ 10 m Ω . Insulation resistance: ≥ 5 -10 m Ω . Dielectric strength: 500V rms. Temperature range: -25°C to $+70^{\circ}\text{C}$.

Cat. No.	Pole	Description	Net Price Each	
			1-49	50-Up
NYS321*	3	Male DIN plug, shell turned brass, nickel finish, flexible strain relief, contacts silver plated.	\$2.02	\$1.01
NYS322*	5	Same as NYS321 above only 180°	2.06	1.03
NYS323*	7	Same as NYS321 above	2.21	1.10
NYS324	3	Female receptacles, stamped housing with nickel plated finish. Silver plated contacts. Complete shielding by ground contacts.	.79	.40
NYS325	5	Same as NYS324 above only 180°	.94	.47
NYS326	7	Same as NYS324 above	1.13	.56

*NOTE: Add "G" to Cat. No. for gold plated contacts.



NEUTRIK REAN RCA PHONO TYPES

Perfect phono plug. All metal. Phono receptacle, for PCB mounting. Phono to phono female adapter.

Cat. No.	Pole	Description	Net Price Each	
			1-49	50-Up
NYS352	2	Metal RCA plug	\$1.15	\$58
NYS352AG	2	Metal RCA plug—gold plated contact and handle	3.07	1.54
NYS352BG	2	Metal RCA plug—gold plated contacts, black plated handle	2.06	1.03
NYS352G	2	Metal RCA plug—gold plated contacts	2.06	1.03
NYS355	2	Metal RCA jack to jack adapter	1.32	.66
NYS354	2	Metal RCA PCB type	.50	.25
NYS367-0	2	RCA chassis jack, gold plated, black	2.76	1.38
NYS367-2	2	RCA chassis jack, gold plated, red	2.76	1.38
NYS367-4	2	RCA chassis jack, gold plated, yellow	2.76	1.38
NYS367-5	2	RCA chassis jack, gold plated, green	2.76	1.38
NYS367-6	2	RCA chassis jack, gold plated, blue	2.76	1.38
NYS367-9	2	RCA chassis jack, gold plated, white	2.76	1.38
NYS373-0	2	Metal RCA plug—gold plated contacts, black connector with black ring	2.66	1.33
NYS373-2	2	Metal RCA plug—gold plated contacts, black connector with red ring	2.67	1.34
NYS373-4	2	Metal RCA plug—gold plated contacts, black connector with yellow ring	2.67	1.34
NYS373-5	2	Metal RCA plug—gold plated contacts, black connector with green ring	2.67	1.34
NYS373-6	2	Metal RCA plug—gold plated contacts, black connector with blue ring	2.67	1.34
NYS373-9	2	Metal RCA plug—gold plated contacts, black connector with white ring	2.67	1.34
NYS374	2	Metal high quality RCA plug—machined, gold plated	3.08	2.46

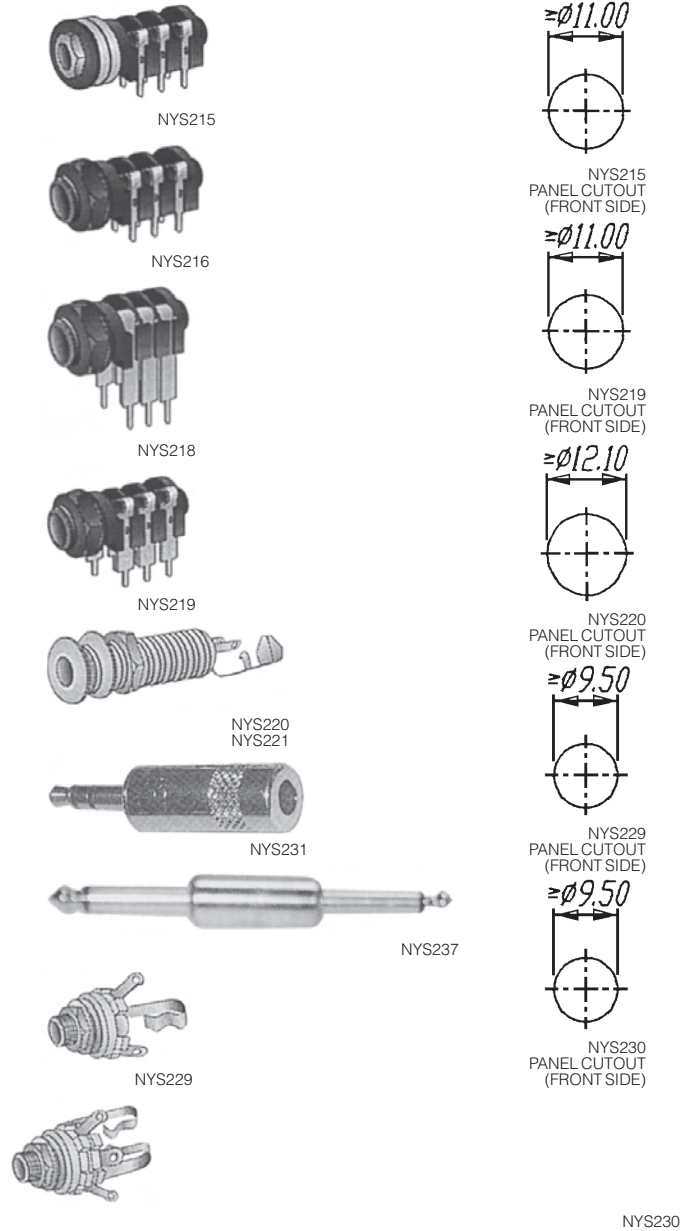

NEUTRIK CHINA 1/4" JACKS

Contact resistance: ≤ 10 m Ω . Insulation resistance: ≥ 2 -10 m Ω . Dielectric strength: 500VDC. Temperature range: -10°C to $+70^{\circ}\text{C}$.

Cat. No.	Pole	Description	Net Price Each	
			1-49	50-Up
NYS215	3	ABS 1/4" stereo jack socket, all contacts switched, metal ferrule, plastic decorative washer, PC mount, 8.2mm	\$.98	\$.49
NYS216	3	ABS 1/4" stereo jack socket, all contacts switched, plastic nut and washers, PC-mount, 8.2mm	.77	.38
NYS218	3	Same as NYS215 above, but 15mm	.79	.40
NYS219	3	Same as NYS215 above, but 12.5mm	.79	.40

Continued on next page....

Pomona Electronics

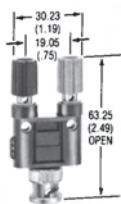

1296



1452

STANDARD DOUBLE BINDING POSTS TO BNC MALE OR FEMALE

Permits single or double banana plugs to be with equipment having a BNC male or female. **UPPER:** Double binding post with captive thumb nut. Brass, nickel plated. Accepts standard banana plugs. Polycarbonate insulation. **INSULATION:** ABS. **LOWER:** BNC male or female. Impedance: 50 Ohms. **RATING:** Operating voltage: 500 VRMS max., +50°C. (+122°F.) max.

Cat. No.	Body Colour	Binding Post	Net Price
1296	Black	One Red, One Black	\$14.75
1452	Black	One Red, One Black	12.37

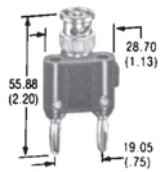

1270

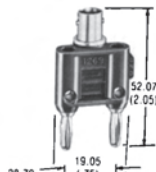

1269

BNC MALE OR FEMALE TO DOUBLE BANANA PLUG

Permits BNC male or female to be used with equipment having banana jacks. Cross holes 4.22mm (.166) dia. in body provide side stackup connections. **UPPER:** BNC male or female. Impedance: 50 Ohms. **INSULATION:** ABS. **LOWER:** Double banana plug. Body, brass. Spring, one piece heat treated beryllium copper, nickel plated. **RATING:** Operating voltage: 500 VRMS max., +50°C. (+122°F.) max.

Cat. No.	BNC	Colour	Net Price
1270	Male	Black	\$11.56
1269	Female	Black	7.89

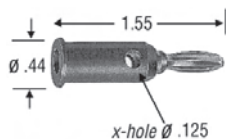

SOLDERLESS STACKUP BANANA PLUG

Internal setscrew holds wire firmly. Accepts standard banana plug, fits standard (.166 dia.) banana jack. Accepts 18-22 AWG wire. **MATERIAL:** Banana Plug/Jack: Brass; Spring: Heat Treated Beryllium Copper; Plating: Nickel. **INSULATION:** ABS. **RATING:** 5000 VDC, 15 Amps, +50°C (+122°F.) Max.

Cat. No.	Colour	Pkg. Qty.	Net Price Per Pkg.
1325-0	Black	10	\$1.71

NOTE: For other colours replace suffix 1325-0 in Cat. No. with 1 = Brown, 2 = Red, 3 = Orange, 4 = Yellow, 5 = Green, 6 = Blue, 7 = Violet, 8 = Grey, 9 = White.



*Max. Insulation dia.

SOLDERLESS STACKUP BANANA PLUG WITH SAFETY COLLAR

Features integral safety collar that insulates exposed wire leads. Wire firmly held in place with internal setscrews, eliminates soldering, simplifies assembly of test leads. **UPPER:** Banana Jack, 4.2 (.166) dia. brass. **LOWER:** Banana Plug. Spring, one piece heat treated beryllium copper. Fits standard banana jack. **RATING:** 5000 VDC, 15 amps, +50°C. (+122°F.). **MATERIAL:** Nickel plated. **INSULATION:** ABS.

Cat. No.	Colour	Pkg. Qty.	Net Price Per Pkg.
1825-0	Black	10	\$1.71

NOTE: For other colours replace suffix 1825-0 in Cat. No. with 1 = Brown, 2 = Red, 3 = Orange, 4 = Yellow, 5 = Green, 6 = Blue, 7 = Violet, 8 = Grey, 9 = White.

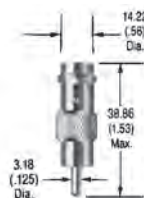

BNC FEMALE TO PHONO PLUG

Permits BNC male to be used with equipment having phono jacks. **UPPER:** BNC female. Nickel plated center contact. Impedance: 50 ohms. **LOWER:** Phono plug. Brass, nickel plated. **RATING:** Operating voltage: 500 VRMS max., +102°C. (+216°F.) max.

Cat. No.	Net Price
5319	\$7.32

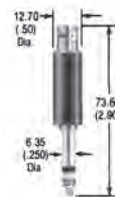

BNC FEMALE TO WE-310 PHONE PLUG

Permits BNC male to be used with equipment having three circuit phone jacks. Readily adapts equipment to available BNC coaxial cables. Tip connected to inner contact of connector and ring connected to shell. Sleeve, no connection. **UPPER:** BNC female. Impedance: 50 ohms. **INSULATION:** ABS. **LOWER:** Phone plug, PJ-051 (equivalent to WE-310). **RATING:** 500 V peak, +50°C. (+122°F.) max.

Cat. No.	Colour	Net Price
2798	Black	\$24.69