

KEYSTONE POWER TRANSISTOR SOCKETS SPACE SAVER SOCKETS FOR TO-3 CASE

Low cost, compact, rugged sockets for easy, fast mounting with the least amount of hardware. Cadmium plated spring brass contacts provide positive contact. The socket is held underneath the chassis and the semiconductor is inserted into the contacts, holding the assembly in position. Both the semiconductor and the socket are then held securely by 6-20 screws threaded into each end of the hard steel collector plate. Phenolic base. Molded nylon top plate with the choice of boss heights eliminates need for separate bushings.

Cat. No.	Boss Height Dim "A"	Nylon Colour	Net Price Each		
			1-19	20-99	100-Up
4601	.090"	Natural	\$1.48	\$1.34	\$1.29
4602	.045"	Blue	1.48	1.34	1.29

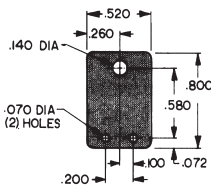

PLASTIC CASE MICA INSULATORS

Cat. No.	Net Price Per 1000
4671	\$47.71

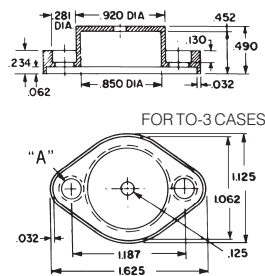
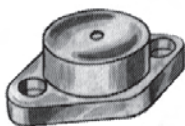

MOLDED NYLON COVERS FOR TO-3 CASES

Molded nylon covers easily mount over and insulate the power transistor. Will withstand temperatures to approx. 300°F. Available with or without brass eyelets installed in mounting holes to assure proper electrical contact with collector/case.

Cat. No.	For	Eyelets Installed	Net Price Per 1000		
			1-499	500-999	1000-Up
4634	TO-3	Two	\$591.07	\$416.11	\$268.69

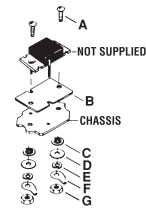

KEYSTONE SEMICONDUCTOR MOUNTING KITS

These pre-packaged universal mounting kits provide all the necessary hardware and insulators required to securely mount the semiconductor to the chassis or heat sink. Individual parts are also available in packages of 100, as shown below. Note that the quantities given refer only to the complete mounting kits, and not to the pricing of the individual items.

Cat. No.	Item	Qty. in Kit	Description	Net Price Each	
				1-499	500-Up
MOUNTING KIT FOR TO-220 CASE					
4724	Complete Mounting Kit			\$1.72	\$1.37
4690	A	1	4-40 Screw	.03	.02
4672	B	1	Mica Insulator	.04	.03
3049	C	1	Shoulder Washer	.07	.05
4693	E	1	Lockwasher	.03	.02
4694	G	1	4-40 Nut	.04	.03

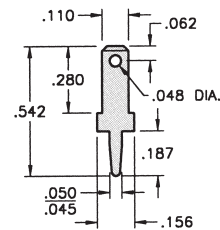

PC QUICK-FIT MALE TERMINALS

Cat. No.	Material	Mounting Hole	Net Price
1267	.020 Brass Tinned	.046 Dia.	\$0.09
1211	.032 Brass Tinned	.052 Dia.	.09

NOTE: Use Quick-Fit Insertion Tool Cat. No. 1288.

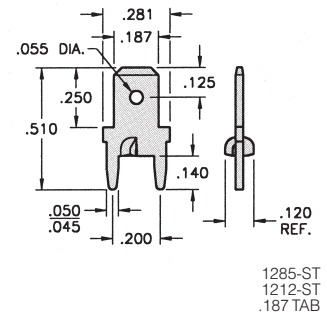
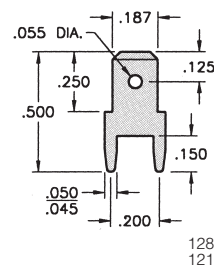

PC QUICK-FIT MALE TERMINALS

Cat. No.	Material	Mounting Hole	Net Price Per 1000
1285	.020 Brass Tinned	.046 Dia.	\$67.28
1212	.032 Brass Tinned	.052 Dia.	73.14

STURDI-MOUNT

1285-ST	.020 Brass Tinned	.046 Dia.	41.25
1212-ST	.032 Brass Tinned	.052 Dia.	44.85

NOTE: Use Quick-Fit Insertion Tool Cat. No. 1288.