



SCHROFF

Project - 0 Item(s)

MY PROJECT LIST

- PRODUCTS**
- APPLICATIONS**
- INDUSTRIES**
- NEW PRODUCTS**
- CONFIGURATORS**
- Products ▾
- Search
-

Home > 19" bracket type F with handle holes for textile sealing

19" bracket type F with handle holes for textile sealing

SCHROFF

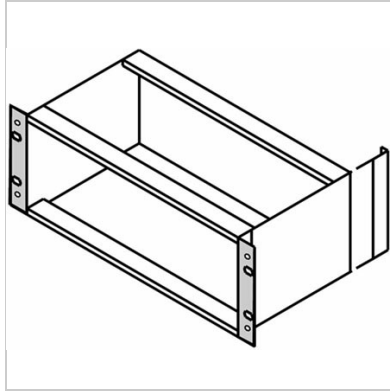

Catalog Number: 24564-498

[Back To Product](#)

- 19" bracket is bolted laterally with the side panel to the horizontal rail
- 19" bracket still has holes for bolting on handles

Product family:

EuropacPRO

Type:

Individual Components

Individual Component Type:

Mounting - Brackets and Accessories

Description:

19" bracket with handle holes

Note:

Please order handles separately



Other Views

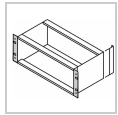

Select product specifications before modifying or adding to project list or requesting a quote.

Height-U-defining

Configuration-defining

[Clear Selection](#)

Quantity

Add Item to Project List +

Documents

- Main Catalog - Subracks
- User manual

Links

- Native CAD files

Technical Data











Height mm	265.9
Qty	PU 1 pair
Description	with handle holes
Height U	6

Delivery Comprises:

Item	Quantity	Description
1	2	19" bracket, aluminium extrusion, rear side: clear chromated, front: anodised

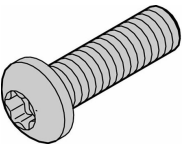
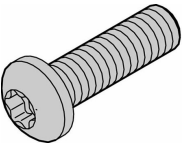
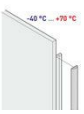
Accessories

	Side panels, Type F	34560-485	Add Item to Project List +
	Side panels, Type F	34560-487	Add Item to Project List +

	Side panels, Type F	34560-489	Add Item to Project List +
	Side panels, Type F	34560-491	Add Item to Project List +
	Side panels, Type F	34560-493	Add Item to Project List +
	Side panels, Type F	34560-495	Add Item to Project List +
	Side panels, Type F	34560-496	Add Item to Project List +
	Side panels, Type F	34579-012	Add Item to Project List +
	Side panels, Type F	34579-038	Add Item to Project List +
	Countersunk screw, torx (M4x10), steel zinc plated, PU 100 pieces	24560-155	Add Item to Project List +
	Countersunk screw, torx (M4x14), steel zinc plated, PU 100 pieces	24560-130	Add Item to Project List +
	EMC shielding textile gasket, -40...+70°C, 6 U, PU 10 pcs	21101-855	Add Item to Project List +
	Front handle, one-piece, 6 U, clear anodised, 1 piece (SPQ 10)	10501-008	Add Item to Project List +
	Front handle, one-piece, black anodised	10501-029	Add Item to Project List +
	Front handle, multi-piece, clear anodised	10502-065	Add Item to Project List +

EXPLORE

[About Us](#)
[Services & Capabilities](#)
[News & Events](#)

CONTACT

[Customer Service](#)
[Find a Sales Office or Distributor](#)
[Global Locations](#)

DOWNLOAD

[Download Center](#)
[Reference Projects](#)
[Videos](#)

[Newsletter Subscriptions](#)

[Strategic Partnerships](#)

[Investor Relations](#)

[Product Compliance & Certifications](#)

[Partner Login](#)

[Product Configurators](#)

[Warranties and Terms of Sale & Procurement](#)

© 2018 nVent. All rights reserved | [Privacy Policy](#) | [Terms of Use](#) | [Cookie Policy](#) | [Imprint](#) | [Site Map](#)

Connect With Us

